



NAYA

— DECORATIVE BUILDING MATERIALS —



Adds Color To Your Wonderful Life.

Home Decoration Design

2015-2026

展厅地址：义乌市稠州北路1135号双创大厦1栋3楼311号

门店地址：义乌市国际商贸城二区2楼14418号(33号门中央大厅连接体)

门店地址：义乌市国际商贸城二区东，5号门一楼1街ED1-20053 20054

门店地址：义乌市全球数贸中心六区142号门3楼3单元2街73489

Exhibition hall address: No. 311, 3rd floor, Building 1, Shuangchuang Building, 1135 North Chouzhou Road, Yiwu City

Store address: No. 14418, 2nd Floor, Zone 2, Yiwu International Trade City (Connecting Body of Central Hall at Gate 33)

Store address: ED1 - 20053, 20054, 1st Street, 1st Floor, Gate 5, East of Zone 2, Yiwu International Trade City

Store address: No. 73489, 2nd Street, Unit 3, 3rd Floor, Gate 142, Zone 6, Yiwu Global Digital Trade Center



WeChat(Exhibition hall)

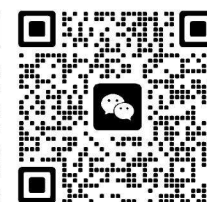

WeChat(14418)



WeChat(20053)



WhatsApp

PRODUCT CATALOGUE

SUPPLIER
MANUFACTURER

DIY
INTERLOCKING
DECK TILES

- WPC Deck Tiles
- PP Deck Tiles
- Grass/Stone Deck Tiles
- Outdoor Decking
- WPC Wall Panel
- Accessories



CLASSIC WPC DECKING TILES



NAME WPC Decking Tiles
SIZE 300*300*20mm(L*W*H)

COLOR



Gray



Coffee



Black



Brick Red



Teak



Chocolate

FINISHING



Striped Groove



3D Online Embossing

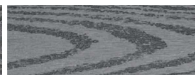

2D Embossing

HOT STYLES

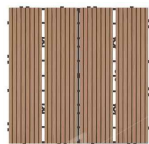

Straight



8 Slats Checker



6 Slats Checker



Flower

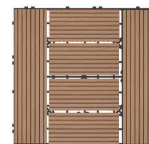

H-type

DIY WPC DECKING TILES

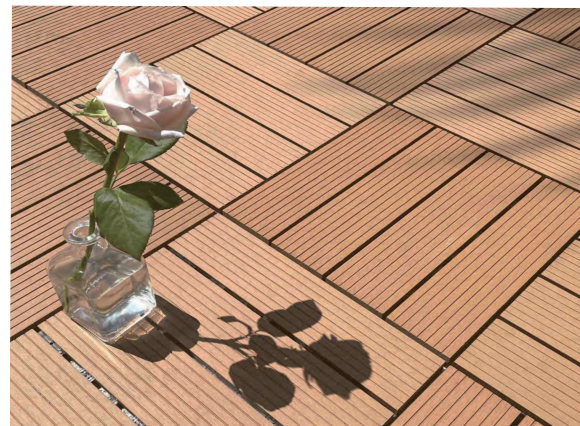

Item No.	Mold	Picture	Size: L*W*H(CM)	Packaging(CM)	1x20GP (PCS)	1x40HC (PCS)
JY-WPSG-4S			30*30*2	32*32*25	12474	28490
JY-WP2D-4S			30*30*2	32*32*25	12474	28490
JY-WP3D-4S			30*30*2	32*32*25	12474	28490
JY-WP3D-3S			30*30*2	32*32*25	12474	28490

WPC CO-EXTRUSION DECKING TILES



NAME	WPC Co-extrusion Decking Tiles
SIZE	300*300*20mm(L*W*H)

COLOR

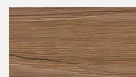

Teak-Brown

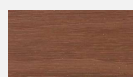

Cherry



Rosewood



Blue-Gray

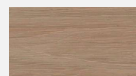

Maple



Antique Oak

FINISHING

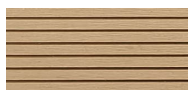

Striped Groove

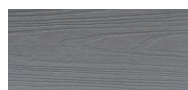

3D Online Embossing

ADVANTAGE

Plastic Base
The use of high quality pp plastic, excellent flexibility, better weather resistance, longer service life.

Research and Development
With co-extruding and covering techniques, the surface of the product cannot be easily scratched. Stands up to harsh weather, and resists stains, scratches, and fading.
Nontoxic/No-Wood Burr.
High Strength /Strong.

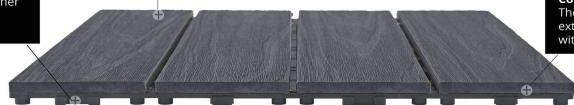

Core Layer
The inner core is still made of extruded wood plastic composite with high density.

DIY WPC CO-EXTRUSION DECKING TILES

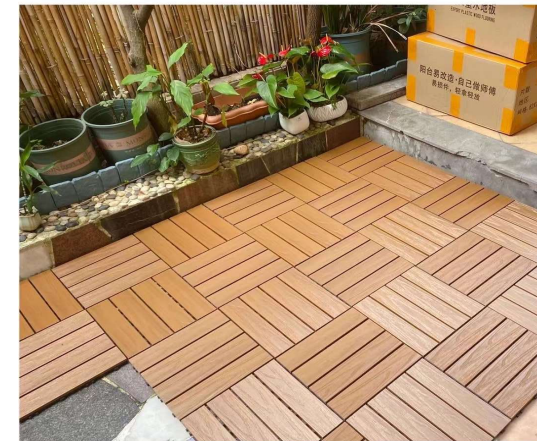

Item No.	Mold	Picture	Size: L*W*H(CM)	Packaging(CM)	1x20GP (PCS)	1x40HC (PCS)
JY-WPCOE-4H			30*30*2	32*32*25	12474	28490
JY-WPCOE-4S			30*30*2	32*32*25	12474	28490

PP PLASTIC DECKING TILES



NAME	PP Plastic Decking Tiles
SIZE	300*300*20mm(L*W*H)

COLOR



STYLES

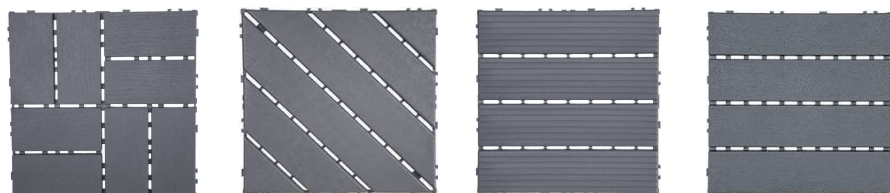

JY-PP8C

JY-PP6D

JY-PP4SG

JY-PP4S

PP PLASTIC DECKING TILES

FREE SPLICING

Multiple Splicing Methods



Item No.	Mold	Picture	Size: L*W*H(CM)	Packaging(CM)	1x20GP (PCS)	1x40HC (PCS)
JY-PP8C			30*30*2	61*31*38	13608	32148
JY-PP6D			30*30*2	61*31*38	13608	32148
JY-PP4SG			30*30*2	61*31*38	13608	32148
JY-PP4S			30*30*2	61*31*38	13608	32148

GRASS / STONE DECKING TILES



JY-AGT-A(Autumn Grass)

JY-AGT-S(Spring Grass)



JY-S-CMBW



JY-S-CMGW



JY-S-CMC



JY-S-CPC



JY-S-S11C





JY-S-S9C



JY-S-S11G



JY-S-S9G

Item No.	Picture	Size: L*W*H (CM)	KG/PCS	1x20GP (PCS)	1x40HC (PCS)
JY-S-S(Slate Stone)		30*30*2	2	8640	/
JY-S-C(Sliced Stone)		30*30*2	2	8640	/
JY-AGT(Artificial Grass)		30*30*2	0.3	15680	36960

DIY GRASS / STONE DECKING TILES

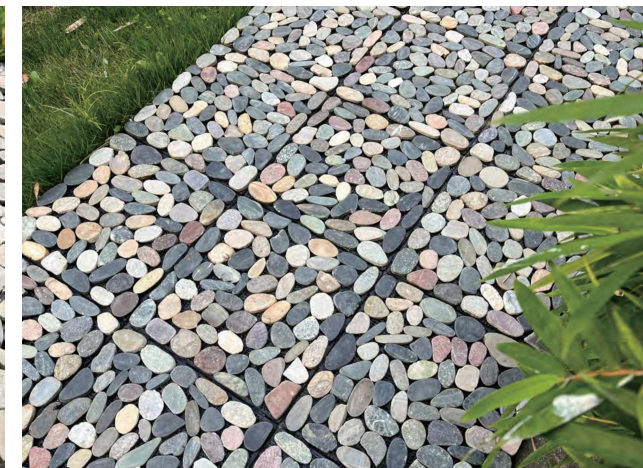
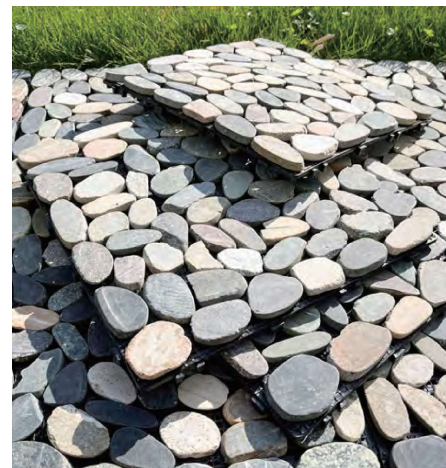
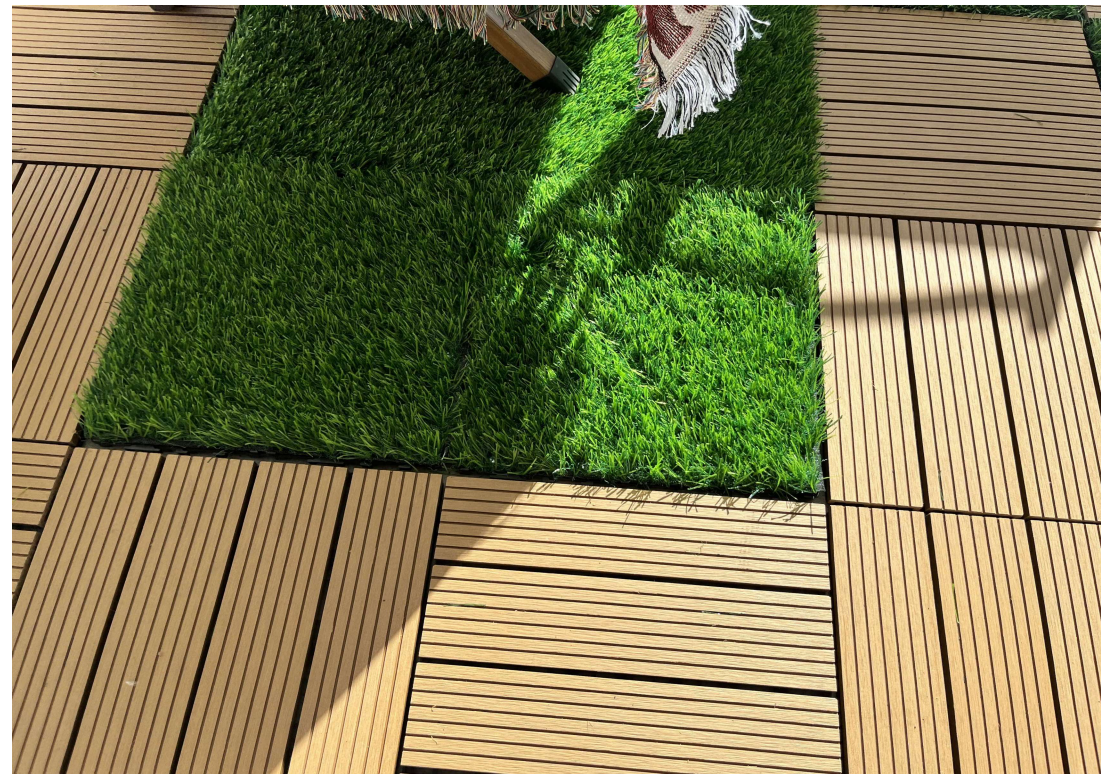

HOW TO INSTALL DIY DECKING TILES

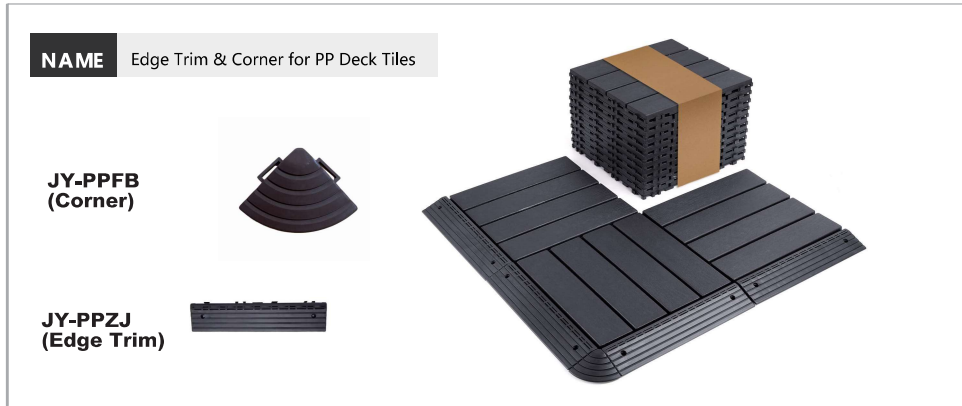

WPC			Plastic		
Item No.	Mold	Picture	Item No.	Mold	Picture
JY-WPCFB			JY-PPZJ	/	
JY-WPCZJ			JY-PPFB	/	

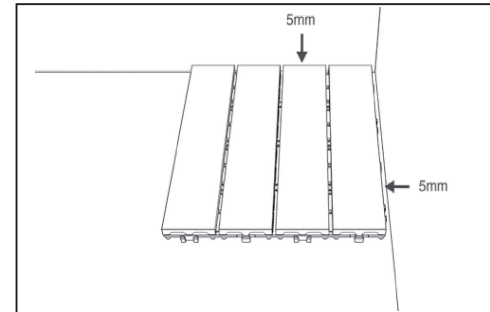

1. Place the first deck tile in the corner and leave a 5mm gap from the wall.

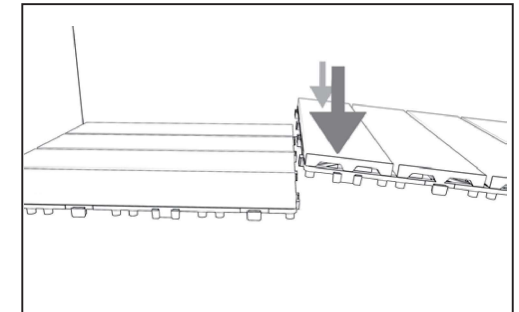

2. Buckle the interlocking clips of the second tile onto the first tile.

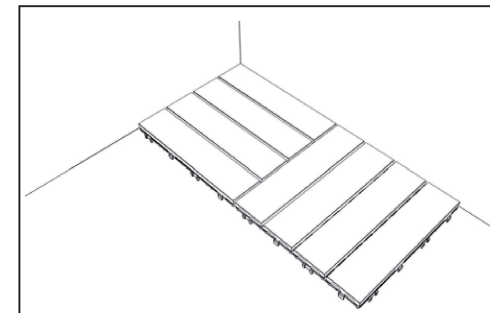

3. Install other deck tiles in this way.

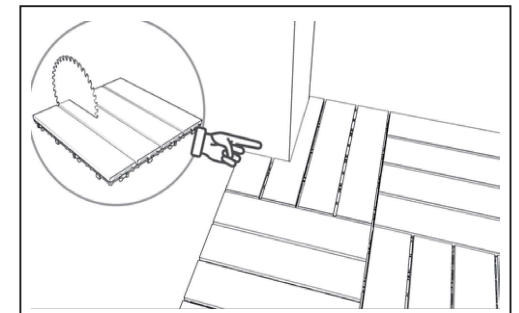

4. To finish installation, any excess parts can be cut with a cutting saw.

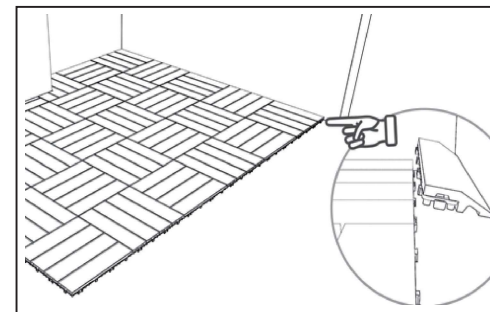

5. Finally, specialized interlocking edge strips and corners are installed around the edges of the floor.

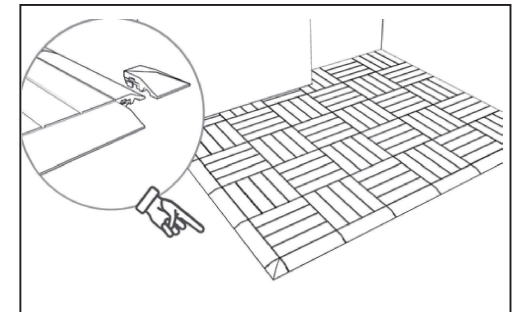

WPC GROOVES DECKING



NAME WPC Hollow Grooves Decking

SIZE 140*25mm(L*W*H)

WPC 3D-EMBOSSED DECKING

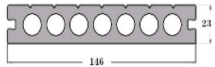

NAME WPC Hollow 3D-Embossed Decking

SIZE 146*23mm(L*W*H)

WPC SOLID 3D-EMBOSSED DECKING



NAME WPC Solid 3D-Embossed Decking

SIZE 150*20mm(L*W*H)

WPC CO-EXTRUSION DECKING

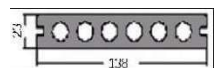

NAME WPC Co-extrusion Decking

SIZE 138*23mm(L*W*H)

COLOR



JY-B01



JY-T01



JY-G01



JY-C01

COLOR



JY-B01



JY-T01



JY-G01



JY-C01

COLOR



JY-B01



JY-T01



JY-G01



JY-C01

COLOR

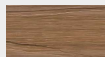

Teak-Brown

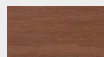

Cherry



Rosewood

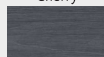

Blue-Gray



Maple



Antique Oak

MAIN COMPONENTS



Screw



Plastic Clip



Side Buckle



Joist

MAIN STEPS

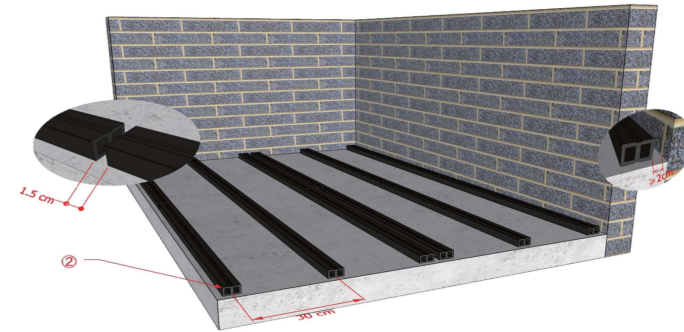

1. Pre-level for leveling the installed ground. If the ground has a waterproof layer, we can use the corner braces to connect and fix the joist mutually.
2. If the joist is closed to the wall, use the expansion screws to fix the joist. After fixing the joist, please use the water to test the flow direction and crevasse to ensure drainage fluently.
3. The space between the joists is usually controlled in 300 mm-400 mm, for the non-public area, the spacing could appropriately relax. But usually not more than the thickness of the decking 14 times.
4. For the liquidity centralized place, the spacing could be appropriately reduced, usually not less than 300mm, In special cases that need engineering inspection and reduced span, pls reference the local building regulations.

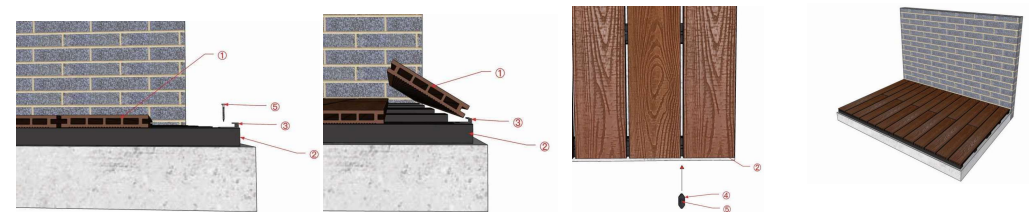
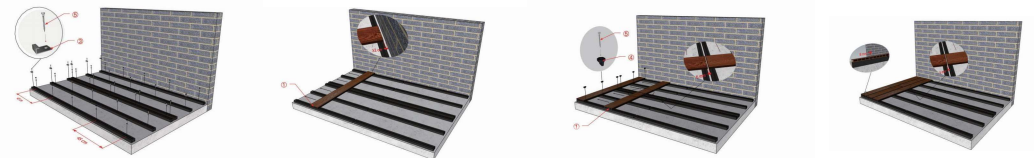

Our company don't undertake the responsibility for failing to install without referring our instruction or occurring damage due to wrongly installation. JOYON reserves the right of final explanation.

WPC CO-EXTRUSION WALL PANEL



NAME WPC Co-extrusion Wall Panel
SIZE 219*26mm(L*W*H)

COLOR



JY-OE-WPL(t): Teak



JY-OE-WPL(oak): Antique Oak



JY-OE-WPL(r): Chocolate



JY-OE-WPL(bg): Blue-Gray

WPC 3D-EMBOSSED WALL PANEL

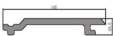

NAME WPC 3D-embossed Wall Panel
SIZE 156*21mm(L*W*H)

COLOR



JY-CL-WPL(g): Gray



JY-CL-WPL(t): Teak



JY-CL-WPL(r): Rosewood



JY-CL-WPL(ch): Chocolate

WPC WALL PANEL

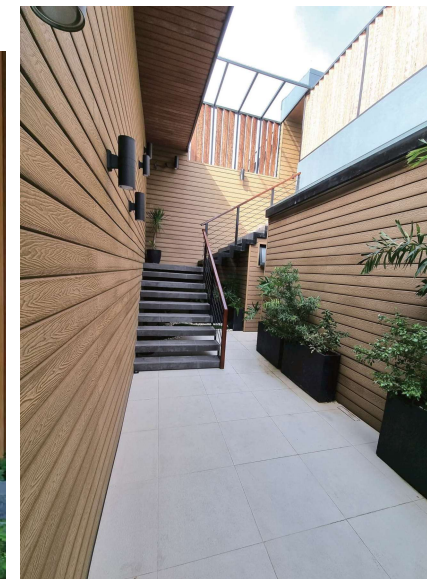
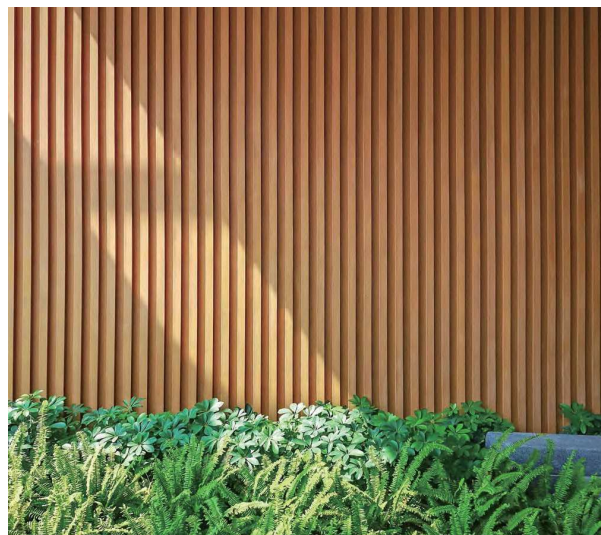

MAIN COMPONENTS



Screw



Side Buckle



Joist



Capping Seal



Step 1
Position carefully.



Step 2
Keep stainless fitting for keel approximately 30cm apart.



Step 3
Screw down the stainless fitting for the keel.



Step 4
Set a starter clip at the end of each joist with a stainless steel screw.



Step 5
Slip the first wall panel against the starter clip firmly.



Step 6
Install the rest of the wall panels into the first wall panel.



Step 7
Drive screws on top of the side cover



Step 8
Finished appearance.

Item No.	Mold	Picture	SIZE(L*W*H)(CM)	Packaging (CM)	1x20GP (PCS)	1x40HC (PCS)
JY-OE-WPL			219*26*2900		1500	3000
JY-CL-WPL			156*21*2900		3700	5600